

2019



XEBEC®

DEBURRING
TECHNOLOGIES

**Innovative Deburring
& Surface Finishing Solutions**

deburringtechnologies.com

Xebec Ceramic Fiber
4
Successful Applications
6

Surface Deburring & Finishing

10

Surface Brush

 Machining
Center

 Combined
Lathe

 Special
Machine

Robot

 Lathe with
Milling

 Drilling
Machine

11

Extra Large Surface Brush

 Machining
Center

 Combined
Lathe

 Special
Machine

12

Wheel Brush

 Machining
Center

 Combined
Lathe

 Special
Machine

Robot

 Lathe with
Milling

13

Self Adjusting Sleeve

 Machining
Center

 Combined
Lathe

 Special
Machine

Robot

 Lathe with
Milling

14

Floating Holder

 Machining
Center

 Combined
Lathe

 Special
Machine

Robot

 Lathe with
Milling

 Drilling
Machine

14

Brush Length Adjustment Tool

Crosshole Deburring & Finishing

16



Crosshole Brush



Machining Center



Combined Lathe



Special Machine



Robot



Lathe with Milling

18



Flexible Shaft Stone



Electric Rotary



Machining Center



Combined Lathe



Special Machine



Robot



Lathe with Milling

20



Back Burr Cutter & Path



Machining Center



Combined Lathe

Detailed Finishing

23

Xebec™ Micro Motor



24



End Type Brush



Electric Rotary



Machining Center



Combined Lathe



Robot



Lathe with Milling

25



Stone Mounted Point



Pneumatic Rotary



Electric Rotary

26



Stone Meister Finish



Electric Rotary



Hand Finishing



Ultrasonic



Pneumatic Rotary

28



Flexible Shaft Stone



Electric Rotary



Machining Center



Combined Lathe



Robot



Lathe with Milling

Operating Parameters

29



Xebec® Ceramic Fiber

For use on materials up to 65Rc

The ceramic fibers are woven to create self-sharpening filaments that maintain consistent cutting action on the tips. Unlike wire and abrasive impregnated nylon brush filaments, the unique design of the Xebec fiber rod maintains its shape with no deformation even after repeated use. This leads to consistent performance time after time.

FINE FINISHING
up to
3.937 Ra
µi microinches
(0.1 µm micrometers)

Continuous Ceramic Fibers

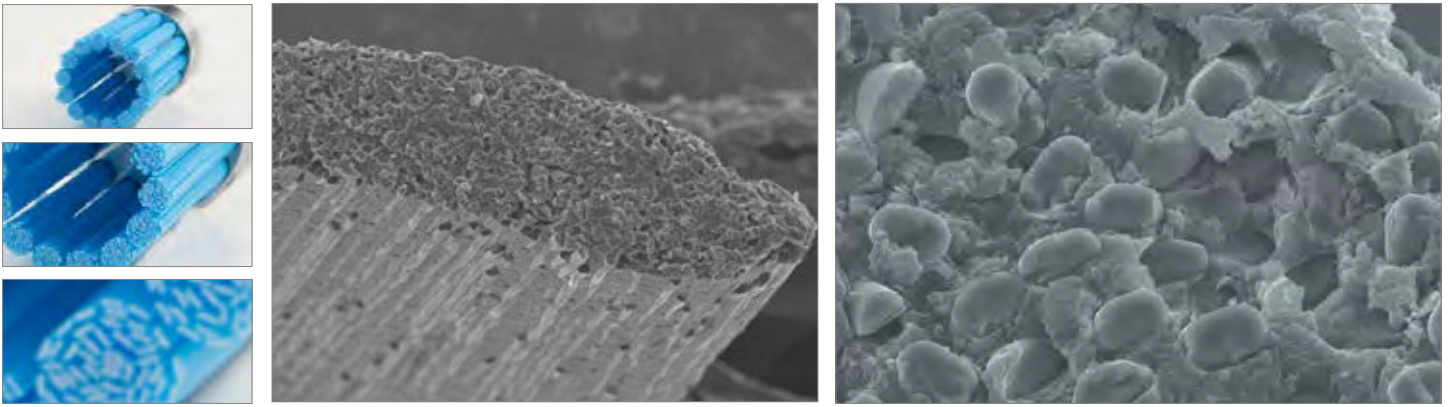

XEBEC Brush™

Ceramic Fibers are formed into bristles to produce tip cutting Brushes

Consistent cutting performance



XEBEC Stone™

Ceramic Fibers are formed into Stones capable of cutting on all sides

Overwhelming grinding power

Tip-To-Tip Consistent Performance

Self-sharpening effect always exposes new cutting edges. Solid fiber materials never deform by repeated use.

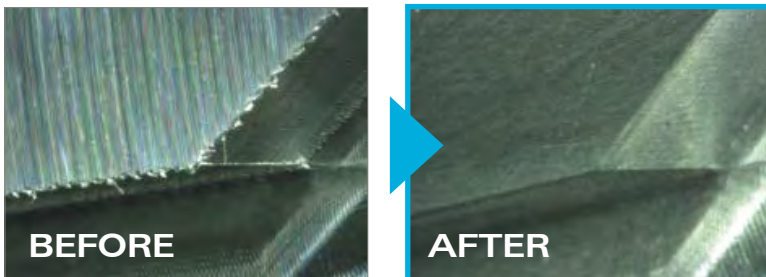

High Grinding Power

The tip of each Fiber works as abrasive. More than 80% of content is Ceramic Fiber.



Innovative Deburring & Surface Finishing Solutions

XEBEC Brush™

Ceramic Fiber bristles will not deform by repeated use.

BEFORE

Individual bristles before and after repeated use

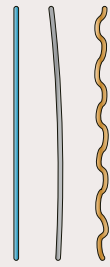

AFTER

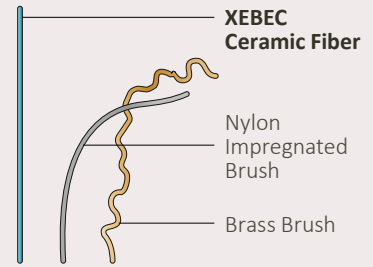

The Advantages of Ceramic Fiber

Xebec Ceramic Fiber brushes remove more material faster than nylon impregnated or brass finishing brushes.

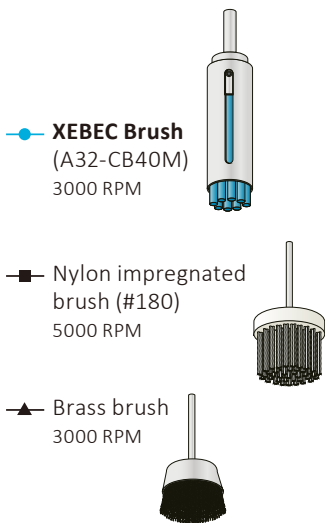

Grinding power

Material: Carbon Steel S45C

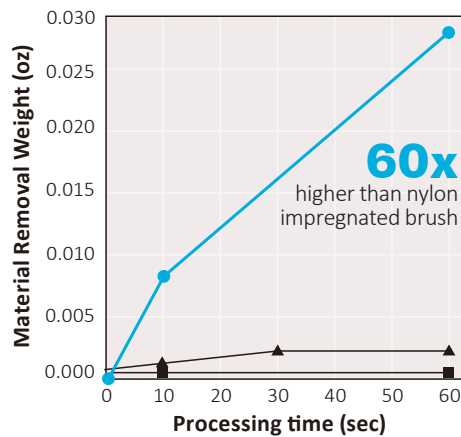

Polishing capacity

Material: Carbon Steel S45C

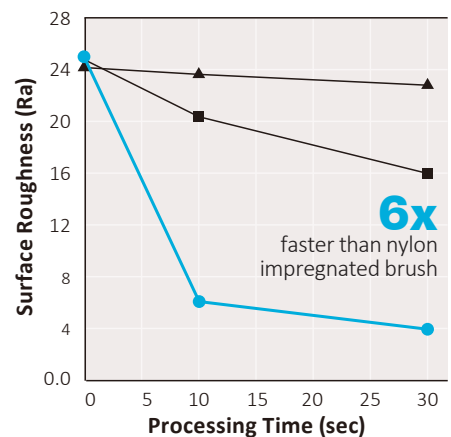

Save time & money! Automate the deburring process.

Ceramic fiber products can be used in CNC, robotic or hand held devices



IMPROVE
QUALITY



INCREASE
PRODUCTIVITY



REDUCE
COSTS



@Xebec Deburring Technologies

Successful Applications

MAJOR MARKETS SERVED

Our focus is identifying and demonstrating value added solutions for production machined parts. We have demonstrated particular success in the following market segments:

Production



- Valves
- Mold & Die
- Fittings
- Precision Parts
- Swiss Machined
- Bushings

Powertrain



- Cylinder Blocks
- Head Covers
- Crankshafts
- Camshafts
- Connecting Rods
- Fuel Injection

Medical



- Tibia Trays
- Bone Screws
- Spinal Implants
- Knees
- Hips
- Shoulders

Edge Deburring

Category	Machine Part
Workpiece	Spur Gear
Material	Carbon Steel S45C
Process Details	Edge deburring after gear cutting process

Precision parts that must be deburred while maintaining edge quality without secondary burrs.

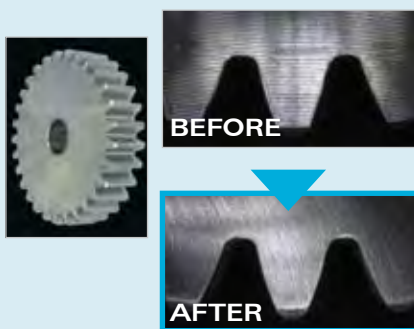

XEBEC product used: A32-CB25M

Rotation Speed: 3500
Depth of Cut: 0.039 in
Feed: 98 IPM

Fine Deburring

Category	Automotive Part
Workpiece	Cooling Fins
Material	Carbon Steel Aluminum Alloy
Process Details	Edge deburring

Fine deburring of surfaces, edge radiuses and small diameter bores. Deburring of fine burrs where the base thickness is 1mm (.040") or less after machine processing and finishing of edges.

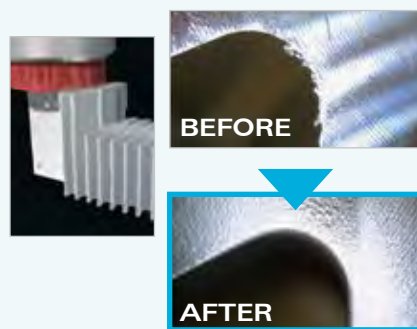

XEBEC product used: A32-CB25M

Rotation Speed: 3500
Depth of Cut: 0.039 in
Feed: 98 IPM

Cutter Mark Removal

Category	Medical Part
Workpiece	Artificial Hip Joint
Material	Titanium Alloy
Process Details	Cutter mark removal after ball end milling

Grinding and finishing of flat surfaces and uneven surfaces.

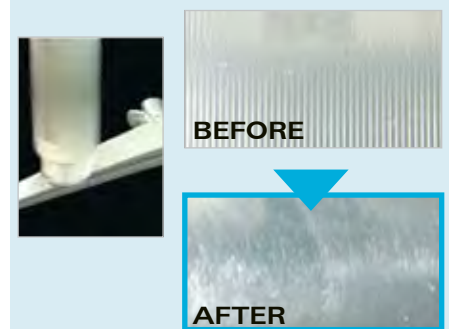

XEBEC product used: A21-CB25M

Rotation Speed: 1500
Depth of Cut: 0.039 in
Feed: 40 IPM

Innovative Deburring & Surface Finishing Solutions

Aerospace



- Landing Gear
- Engine Components
- Blades
- Structural Parts
- Fuel Systems
- Actuation Systems

Firearms



- Slides
- Frame
- Barrels
- Hammers
- Triggers
- Cylinders

Energy



- Manifolds
- Christmas Tree
- Blisks
- Rotor Blades End
- Turbine Blades
- Rotor Blades Blend

Fine Surface Finishing

Category	Airplane Part
Workpiece	Body
Material	Aluminum Alloy
Process Details	Deburring of end milled surface

Fine surface finishing of large parts, deburring of edge radiuses after machine processing and finishing of edges.

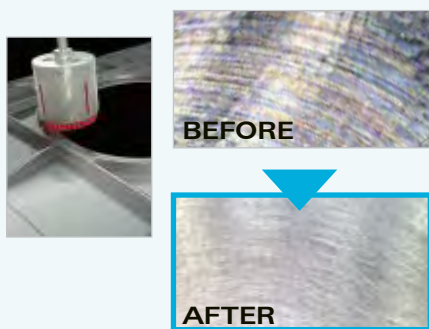

XEBEC product used:
A11-CB100M

Rotation Speed: 960
Depth of Cut: 0.026 in
Feed: 134 IPM

Detailed Surface Finishing

Category	Firearm Part
Workpiece	Trigger Assembly
Material	Stainless Steel
Process Details	Edge deburring and detailed surface finish

Fine surface finishing of detailed parts, deburring of edge radiuses and finishing of edges.

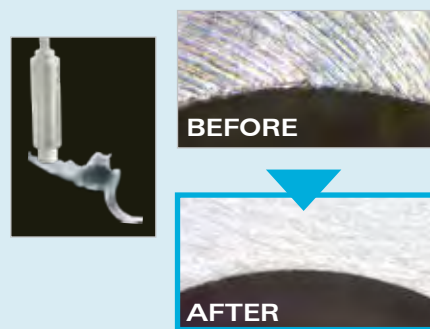

XEBEC product used:
A21-CB06M

Rotation Speed: 8100
Depth of Cut: 0.015 in
Feed: 40 IPM

Fine Surface Finishing

Category	Compressor Part
Workpiece	Turbine blade
Material	SUS316
Process Details	Deburring of ball end milled surface

Fine surface finishing of parts, deburring of edge radiuses after machine processing and finishing of edges.

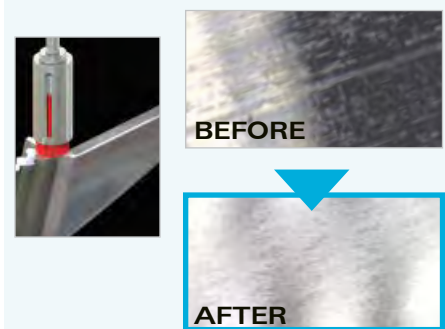

XEBEC product used:
A11-CB25M

Rotation Speed: 1000
Depth of Cut: 0.020 in
Feed: 94 IPM







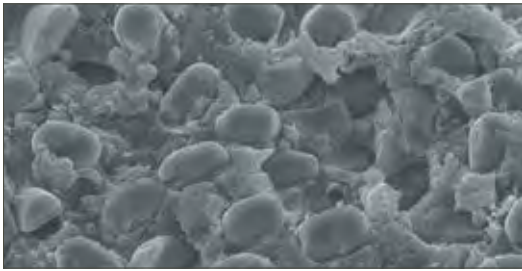

Surface Deburring & Finishing

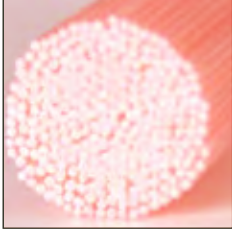
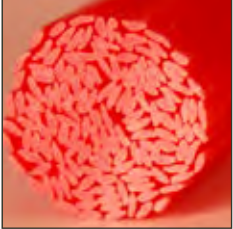

@Xebec Deburring Technologies

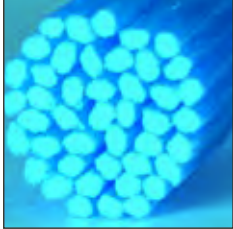

All Xebec brushes are made from the same proprietary ceramic fibers manufactured into rods, or bristles, of different thicknesses. **The greater the bristle thickness, the more aggressive the cutting action.**

Brush Color Signifies the relative thickness of the bristles				
	Will not change part dimensions or features	Will conform to slight workpiece variations	Able to run at higher speeds, extend tool life	3-4 times more aggressive than white
Aggressiveness	Least ← ————— → Most			
Flexibility Ability to conform to the work piece				
Target Material	← Softest		Hardest →	
	Resins, Plastics		Aluminum, Copper, Brass, General Steel	
			Cast Metal, Stainless, Heat-Resistant Steel	
Target Burr Size	Micro Fine		up to 0.008"	
			up to 0.004"	
Target Finish	4 Ra or better		Finish up to 4 Ra	

Target Burr Size

Burr Root Thickness of **0.008"** or less (Burrs are bent with a fingernail)

Burr Root Thickness

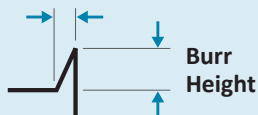

Choosing the Ideal Brush Size

Choose a brush 1.5 to 2 times wider than the width of the work piece surface.

1.5-2x larger than the surface width

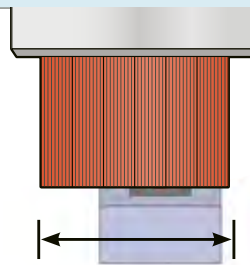

This allows the brush to engage the edge at 90° for optimal grinding power. Using a larger brush than the surface width will also require the fewest number of passes and minimize cycle time.

XEBEC BRUSH™ SURFACE

Surface Brush

Ideal for simultaneous deburring and edge finishing, cutter mark removal and surface polishing



Brush Requires Brush Sleeve to Operate

Brush Size (D3)		Aggressiveness				L4 Brush Length		Max RPM	Required Sleeve
MM	INCHES	Pink ←	Red	White	→ Blue	MM	INCHES		
6mm	0.236	30015 A13-CB06M	30006 A11-CB06M	30012 A21-CB06M	30045 A32-CB06M	30	1.181	10,000	40006
15mm	0.591	30013 A13-CB15M	30005 A11-CB15M	30011 A21-CB15M	30044 A32-CB15M	50	1.969	6,000	40005 or 40007*
25mm	0.984	-	30004 A11-CB25M	30010 A21-CB25M	30043 A32-CB25M	75	2.953	5,000	40004
40mm	1.575	-	30003 A11-CB40M	30009 A21-CB40M	30042 A32-CB40M	75	2.953	3,000	40003
60mm	2.362	-	30002 A11-CB60M	30008 A21-CB60M	30041 A32-CB60M	75	2.953	2,000	40002
100mm	3.937	-	30001 A11-CB100M	30007 A21-CB100M	30040 A32-CB100M	75	2.953	1,000	40001

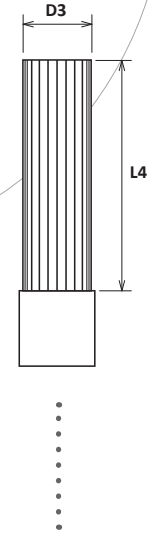

Sleeve for use with Xebec™ Brush Surface

Size	EDP	Material	Part No.	D1		D2		L1		L2		L3	
				MM	INCHES	MM	INCHES	MM	INCHES	MM	INCHES	MM	INCHES
6mm	40006	Aluminum	S06M	6	0.236	10	0.394	70	2.756	29	1.142	41	1.614
15mm*	40005	Aluminum	S15M-A	6	0.236	18	0.709	90	3.543	29	1.142	61	2.402
15mm*	40007	Plastic	S15M-P	6	0.236	18.5	0.728	90	3.543	29	1.142	61	2.402
25mm	40004	Aluminum	S25M	8	0.315	30	1.181	140	5.512	30	1.181	110	4.331
40mm	40003	Aluminum	S40M	10	0.394	45	1.772	140	5.512	30	1.181	110	4.331
60mm	40002	Aluminum	S60M	12	0.472	65	2.559	150	5.906	35	1.378	115	4.528
100mm	40001	Aluminum	S100M	16	0.630	110	4.331	162	6.378	40	1.575	122	4.803

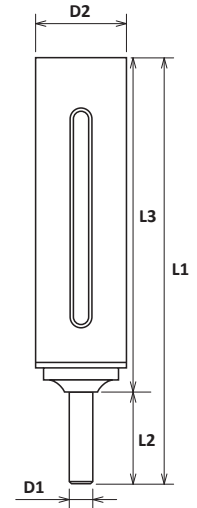

*15mm Sleeve available in Aluminum or Plastic

See Operating Parameters for Surface Brush page 30-31

XEBEC BRUSH™ SURFACE

Extra-Large Brush

Ideal for deburring, cutter mark removal and surface polishing with a width of 4 inches or greater, such as cylinder heads, cylinder blocks and machinery beds.

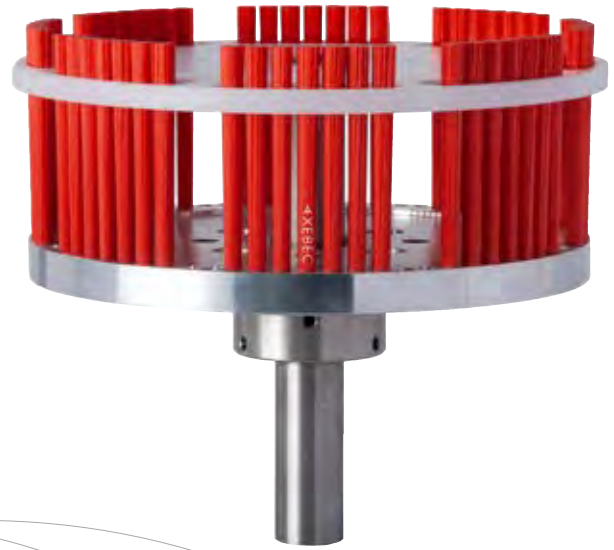

Surface Deburring & Finishing

Brush Requires Slide Ring to Operate

Brush Size (D3)		Aggressiveness			L4 Brush Length		Max RPM
MM	INCHES	Less ←	→ More		MM	INCHES	
		Red	White	Blue			
125mm	4.921	30025 A11-CB125M	30026 A21-CB125M	30046 A32-CB125M	102	4.016	1,000
165mm	6.496	30028 A11-CB165M	30029 A21-CB165M	30047 A32-CB165M	102	4.016	750
200mm	7.874	30031 A11-CB200M	30032 A21-CB200M	30048 A32-CB200M	102	4.016	600

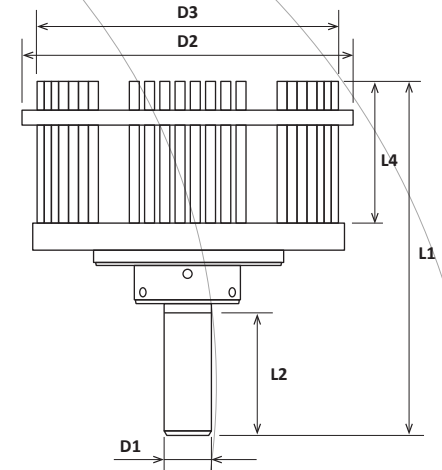

Slide Ring for use with Extra-Large Surface Brush

Size	EDP	Part No.	D1 Shank Diameter		D2 Ring Diameter		L1 Overall Length		L2 Shank Length	
			MM	INCHES	MM	INCHES	MM	INCHES	MM	INCHES
125mm	40010	SR125M	25	0.984	135	5.315	175	6.890	65	2.559
165mm	40011	SR165M			176	6.929				
200mm	40012	SR200M			211	8.307				

Brush Diameter (mm)	Depth of Cut (inches)					RPM		Feed Rate (mm/min)			Recommended Brush Projection (inches)
	Vertical Burr	Horizontal Burr	Cutter Mark Removal	Polishing	Max.	Initial	Max.	Burr Root Thickness		Cutter Mark Removal	
								0.05 in	0.1 in		
125	0.02	0.04	0.02 - 0.04	0.01 - 0.02	0.06	800	1000	160	100	15	0.6
165						600	750				
200						480	600				

Wheel Brush

Ideal for deburring and polishing of side surfaces and inner diameters

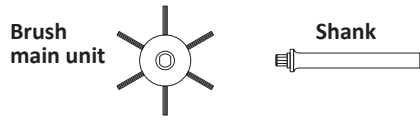

Wheel Brush Reusable Shank Sold Separately, See Below

Size	EDP	Part No.	D2 Head Diameter		D3 Brush Diameter		L3 Head Thickness		L4 Brush Height		Max RPM
			MM	INCHES	MM	INCHES	MM	INCHES	MM	INCHES	
50mm	60007	W-A11-50	23	0.906	50	1.969	9.6	0.378	8	0.315	3,000
75mm	60008	W-A11-75	23	0.906	75	2.953	9.6	0.378	8	0.315	3,000

Insert shank into brush before use.

Shank Wheel Brush Required

Shank	EDP	Part No.	D1 Shank Diameter		L2 Shank Length	
			MM	INCHES	MM	INCHES
70 mm Shank	60009	WSM	8	0.315	70	2.756
150 mm Shank	60010	WSL	12	0.472	150	5.906

*Not suitable for use on hand held devices

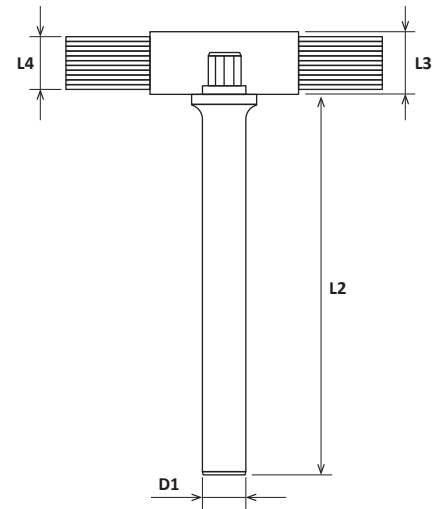
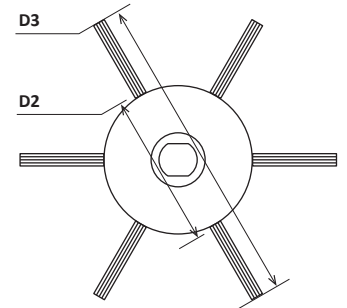

Initial Processing Conditions

EDP	Minimum RPM	Depth of cut (inches)	Feed rate (in/min)
60007	1,600	0.008	190
60008	1,000	0.008	120

*As bristles wear, bristle length shortens and stiffness increases. If bristle breakage occurs, decrease the depth of cut.

If burrs remain

1. Increase the number of passes
2. Decrease the feed rate in 10 to 20% increments
3. Increase Depth of Cut (up to 0.02 inches)

Rotational Direction

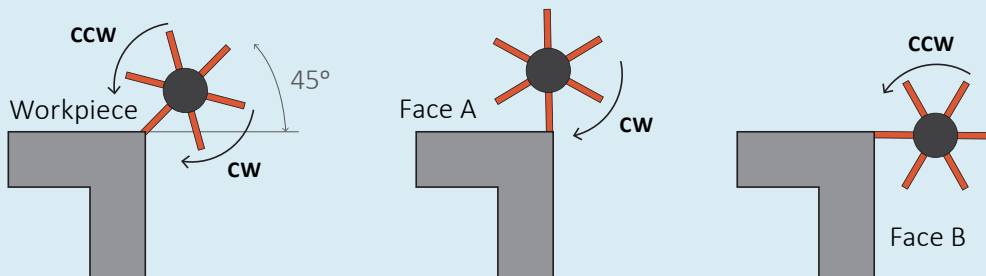

XEBEC BRUSH™

Self-Adjusting Sleeve™

Programmable brush length adjustment solution.
 Completely automated allows for unmanned operations.
 Maintains optimal cutting efficiency with reduced downtime.

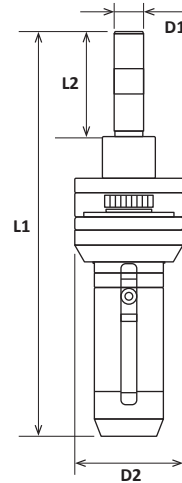
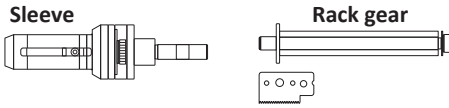

Surface Deburring & Finishing

For Brush Diameter	EDP	Part No.	D1		D2		L1		L2		Weight (lbs)	Max RPM	Compatible Brush (EDP)
			MM	INCHES	MM	INCHES	MM	INCHES	MM	INCHES			
6 mm Brush	50010	XP-AUT06M	10	0.394	37	1.457	124.1	4.886	35.0	1.378	0.485	10,000	30015, 30006, 30012, 30045
15 mm Brush	50011	XP-AUT15M	10	0.394	37	1.457	136.3	5.366	35.0	1.378	0.595	6,000	30013, 30005, 30011, 30044
25 mm Brush	50012	XP-AUT25M	16	0.630	60	2.362	189.0	7.441	41.5	1.634	1.753	5,000	30004, 30010, 30043
40 mm Brush	50013	XP-AUT40M	16	0.630	60	2.362	189.0	7.441	41.5	1.634	2.006	3,000	30003, 30009, 30042

Automated Brush Length Projection

Predetermined brush length is automatically projected when the embedded side gear passes the rack gear which is mounted in a machine.

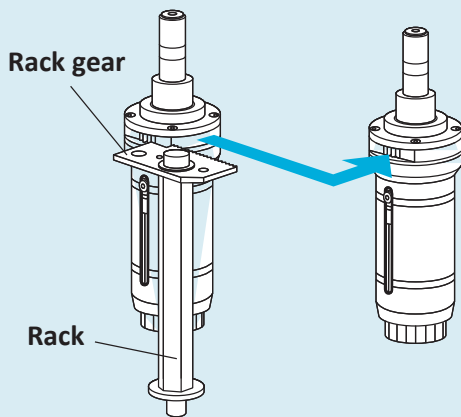

Pass the side gear of main body through the rack gear as shown above.

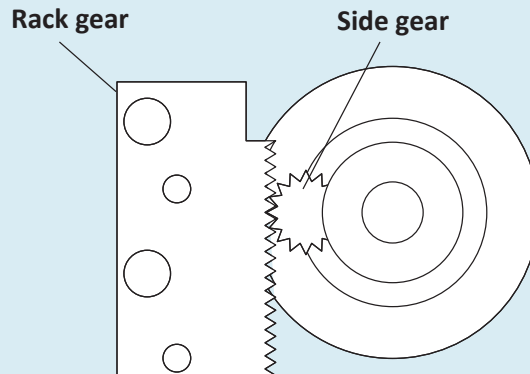

Mesh the side gear of main body and the rack gear.

Floating Holder

Adjustable pressure control using a built-in spring.

Provides more consistent finish and longer brush life for heavy applications.

For Brush Diameter	EDP	Part No.	D1 Shank Diameter		L1 Overall Length		Axial Float		Gage Length		Compatible Sleeve (EDP)
			MM	INCHES	MM	INCHES	MM	INCHES	MM	INCHES	
6 mm	50002	FH-ST12-SL10	12	0.472	95.5	3.760	6	0.236	60.5	2.282	40006
15 mm											40005, 40007
25 mm											40004
40 mm											40003
60 mm	50006	FH-ST20-60	20	0.787	96.4	3.795	6	0.236	51.5	2.028	40002
100 mm	50005	FH-ST20-100	20	0.787	96.4	3.795	6	0.236	51.5	2.028	40001

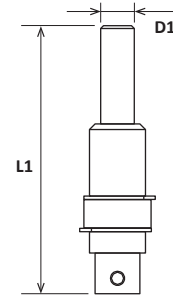

Floating Holder Operation

1. While Brush is not in motion, lower it vertically until contacting the workpiece. Do not contact side of Brush with workpiece as it will damage the bristles.
2. Set the depth of cut and contract the spring.
3. Begin rotation and start feeding.
4. When complete, stop rotation and feed.
5. Remove the tool upward

Length Adjustment Tool

Quickly measure and adjust brush length manually without removing Brush from the machine.

EDP	Item	Part No.
50004	Brush Length Adjustment Tool	XP-EZ-001

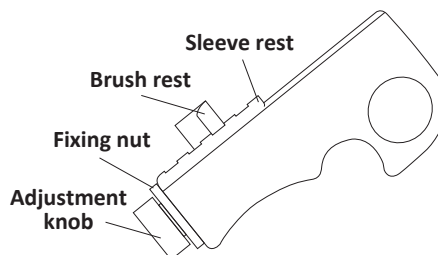

Crosshole Deburring & Finishing

Crosshole Brush

Crosshole diameter cannot exceed 50% of primary bore diameter.

- Removal of fine burrs (base thickness is 0.1mm (.0039”) or less) generated around cross-holes
- Polishing of inner wall surfaces of cylinders such as screw holes
- Polishing the bottom surface of dead-end holes

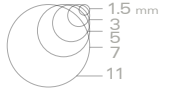

Target Bore Diameter	Brush Size (D3)		L1 Overall Length		L4 Brush Length		D1 Shank Diameter		D2 Neck Diameter		Aggressiveness Less ← → More		Max RPM
	MM	INCHES	MM	INCHES	MM	INCHES	MM	INCHES	MM	INCHES	Red	Blue	
	0.140 - 0.197" (3.5 - 5 mm)	1.5mm	0.060	120	4.724	50	1.969	3	0.118	2.5	0.098	20007 CH-A12-1.5M	
0.197 - 0.315" (5 - 8 mm)	3mm	0.118	130	5.118	60	2.362	3	0.118	4	0.157	20001 CH-A12-3M-TL	-	12,000
			180	7.087			4	0.158			20004 CH-A12-3L-TL	-	
			130	5.118			3	0.118			-	20008 CH-A33-3M	
			180	7.087			4	0.158			-	20012 CH-A33-3L	
0.315 - 0.394" (8 - 10 mm)	5mm	0.197	130	5.118	60	2.362	6	0.232	6	0.236	20002 CH-A12-5M-TL	-	12,000
			180	7.087							20005 CH-A12-5L-TL	-	
			130	5.118							-	20009 CH-A33-5M	
			180	7.087							-	20013 CH-A33-5L	
0.394 - 0.551" (10 - 14 mm)	7mm	0.276	130	5.118	60	2.362	6	0.232	8	0.315	20003 CH-A12-7M-TL	-	12,000
			180	7.087			8	0.315			20006 CH-A12-7L-TL	-	
			130	5.118			6	0.232			-	20010 CH-A33-7M	
			180	7.087			8	0.315			-	20014 CH-A33-7L	
0.551 - 0.787" (14 - 20 mm)	11mm	0.433	130	5.118	60	2.362	12	0.472	12	0.472	20018 CH-A12-11M	-	12,000
			180	7.087							20017 CH-A12-11L	-	
			130	5.118			-	20011 CH-A33-11M					
			180	7.087			-	20015 CH-A33-11L					

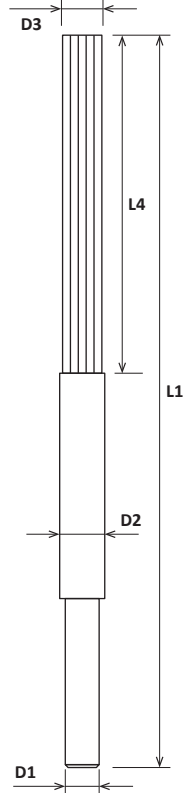

Custom Extra-Long Crosshole Brushes are available for depths exceeding 5.9 inches. This is a Special Order item consisting of brush collar and shank. Contact Customer Service for details.



For Target Bore Diameters larger than 0.8 inches use Surface Brush.
See Operating Parameters for Large Bore Crosshole page 29

Choosing Brush Diameter

Target Bore Diameter	0.140-0.197" (3.5 - 5 mm)	0.197-0.315" (5 - 8 mm)	0.315-0.394" (8 - 10 mm)	0.394-0.551" (10 - 14 mm)	0.551-0.787" (14 - 20 mm)
Brush Size	1.5 mm	3 mm	5 mm	7 mm	11 mm

Choosing Brush Color

Brush Color	Red	Blue
Aggressiveness	Least ←	→ Most
Workpiece Material	Resin	General steel
	Copper/Brass	Stainless steel
	Aluminum	
		Heat-resistant steel
		Cast-iron
Burr Thickness	Micro fine burrs	
		Burr root thickness up to 0.004"
Target Finish	4 Ra or better	Up to 4 Ra

Suggested Starting Parameters

Feed Rate

12 to 15 IPM (inches/min)

Starting Speed (RPM)

	Red	Blue
1.5 mm	9,000-11,000	-
3 mm	7,000-10,000	7,500-9,000
5 mm	8,000-10,000	7,500-8,000
7 mm	7,000-9,000	6,500-8,000
11 mm	6,000-7,500	6,500-8,000

How to Operate

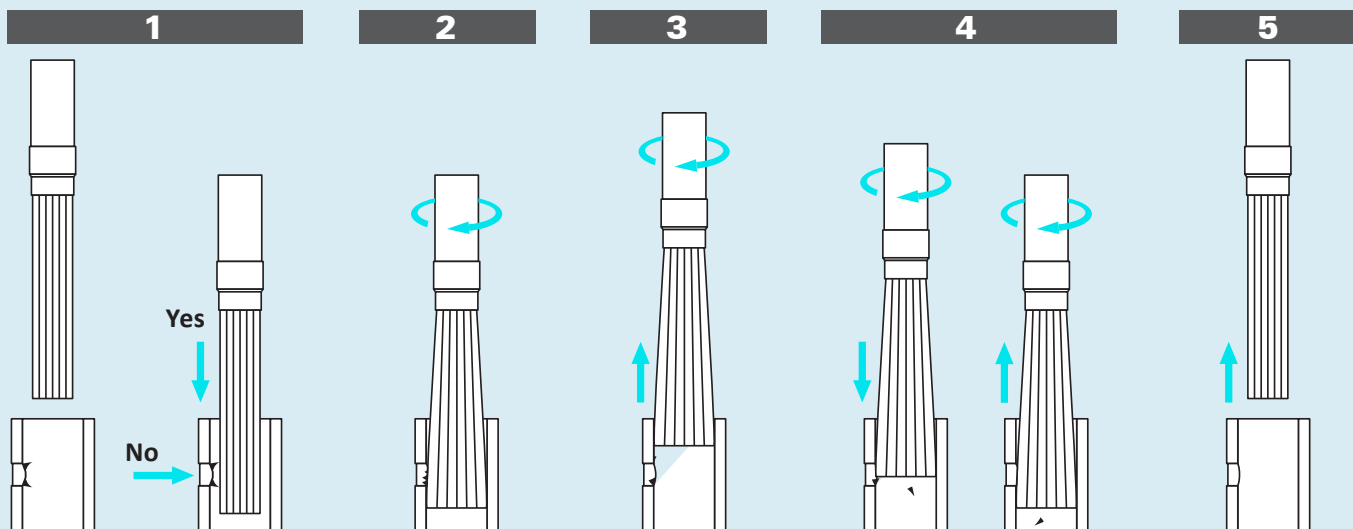

1. Insert the Brush while at rest. Rotating brush outside cylinder may damage brush or injure operator.
2. Rotate the tool past the crosshole. (Rotate in both CW and CCW directions for best results.)
3. Process, pulling the brush back past crosshole to prevent burrs from laying flat against the interior.
4. If required, process bore again, pushing the brush forward past the crosshole and then back.
- 5 Stop brush rotation. Remove the brush while at rest.

Flexible Shaft Stone



Soft contact abrasive ceramic fiber stone. Cutting edges exposed across the entire surface.
For deburring crossholes and detailed finishing of parts

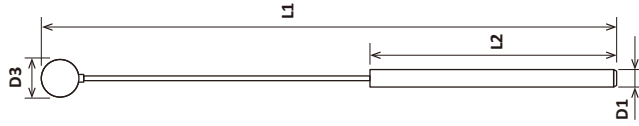

Ball Type

Ball Size (D3)		L1 Overall Length		D1 Shank Diameter		L2 Shank Length		Aggressiveness			Max RPM
MM	INCHES	MM	INCHES	MM	INCHES			Less ←	→ More		
3mm	0.118	71.5	2.815	3	0.118	30	1.181	Blue - #800	Orange - #400	Gray - #220	15,000
								10001 CH-PB-3B	10008 CH-PO-3B	10015 CH-PM-3B	
4mm	0.157	73	2.874					10002 CH-PB-4B	10009 CH-PO-4B	10016 CH-PM-4B	
5mm	0.197	72	2.835					10003 CH-PB-5B	10010 CH-PO-5B	10017 CH-PM-5B	
6mm	0.236	75	2.953					10004 CH-PB-6B	10011 CH-PO-6B	10018 CH-PM-6B	
10mm	0.393	72.5	2.854						10027 CH-PM-10B	7,000	
3mm	0.118	152.5	6.004	2.3	0.091	-	-			10080 CH-PM-3B-L	1,000
4mm	0.157	151.5	5.965							10081 CH-PM-4B-L	3,000
5mm	0.197	153	6.024							10082 CH-PM-5B-L	3,000
6mm	0.236	152	5.984							10083 CH-PM-6B-L	3,000

10mm Ball Available Upon Request

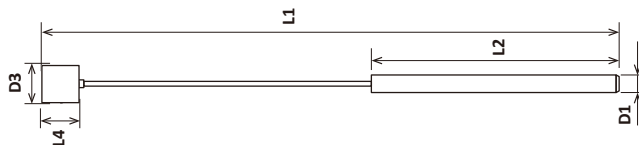

Cylinder Type

Cylinder Size (D3 x L4)		L1 Overall Length		D1 Shank Diameter		L2 Shank Length		Aggressiveness			Max RPM
MM	INCHES	MM	INCHES	MM	INCHES	MM	INCHES	Less ←	→ More		
3 x 3	0.118 x 0.118	71.5	2.815	3	0.118	30	1.181	Blue - #800	Orange - #400	Gray - #220	15,000
								10005 CH-PB-3R	10012 CH-PO-3R	10019 CH-PM-3R	
4 x 4	0.157 x 0.157	72	2.835					10006 CH-PB-4R	10013 CH-PO-4R	10020 CH-PM-4R	
5 x 5	0.197 x 0.197	72.5	2.854					10007 CH-PB-5R	10014 CH-PO-5R	10021 CH-PM-5R	
5 x 10	0.197 x 0.393	75	2.953						10022 CH-PM-5R-C01	12,000	

Stone Color	Blue	Orange	Gray
Grit	#800	#400	#220



XEBEC Stone™

Ceramic Fibers are formed into Stones capable of cutting on all sides

Starting Operating Parameters

Stone should be about 25% larger than the crosshole, but smaller than the bore.
Do not flex the shaft of the tool more than 0.08 inches.

Material	Description	3mm Stone	4mm Stone	5mm Stone	6mm Stone
		RPM	RPM	RPM	RPM
Aluminum Castings	1000- 3000	● 12,000	● 9,100	● 7,000	● 6,100
Aluminum Castings	5052- 6061	● 13,000	● 9,900	● 7,600	● 6,600
Copper Brass	C93200- B- 148-52	● 12,000	● 9,100	● 7,000	● 6,100
Carbon Steel Alloys	1010- 1060	● 13,500	● 10,200	● 7,800	● 6,800
Low Alloy Steel	S1- O2- 4140- 5150	● 13,700	● 10,300	● 8,000	● 7,000
High Alloy Steel	H11- T15- M42	● 13,900	● 10,400	● 8,200	● 7,200
Stainless Steel/ Castings	403- 405- 17- 4 PH	● 13,500	● 10,200	● 8,000	● 7,000
300 Series Stainless	304- 316	● 12,200	● 9,300	● 7,200	● 6,200
Cast Iron - Gray & Nodular	All	● 13,200	● 9,900	● 7,600	● 6,600
White/Hardened Cast Iron	All	● 14,500	● 11,000	● 8,700	● 7,600
Titanium	TiAL6V4- 6V6AL2Sn	● 14,000	● 10,500	● 8,200	● 7,300
High Temp Alloys	Inconel- Hastelloy	● 14,500	● 11,000	● 8,700	● 7,600
Maximum RPM		15,000	13,000	12,000	10,000

Back Burr Cutter & Path

Spherical deburring Cutter with a custom-made tool Path. For CNC deburring of entry and exit holes in a single pass.

Spherical Cutting Tool

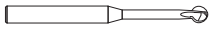

Custom Path Data



The tool can be mounted on machining center (XYZ-axis) or combined lathe (XZY or XZC-axis). 3-axis simultaneous control is required.



Machining Center



Combined Lathe

Xebec™ Back Burr Cutter

Micro-Grain Cemented Carbide

Spherical Cutter

Helical Blade

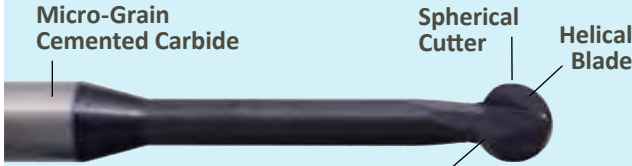

Heat-resistant AlTiCrN coating

Performs well in all materials including Titanium and Inconel

Xebec™ Generated Custom Tool Path

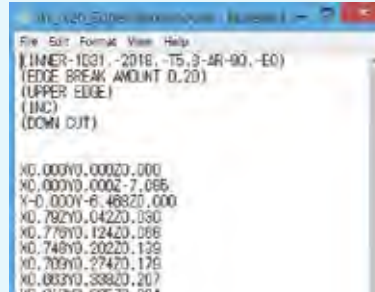

Custom Point Group Data

Up and Down Cutting Directions
Incremental and Absolute Modes
5 levels of Depth of Cut

Once approved, the Path Data is provided via email for immediate use on machine.

For a variety of edge shapes

One Cutter size supports various edges in different sizes and shapes.

Orthogonal cross hole

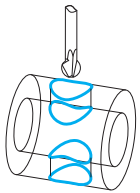

Off-center cross hole

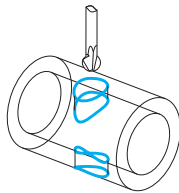

Angled cross hole

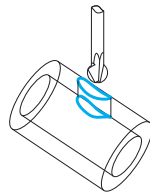

Broken cross hole

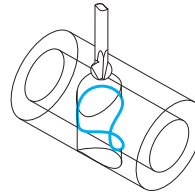

Slotted hole

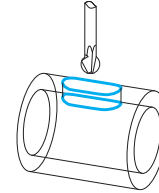

Planar hole

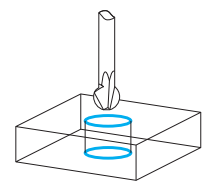

Stainless Steel

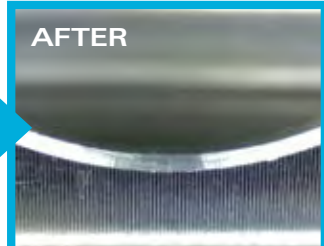

Longer Tool Life

Uses the entire cutting blade by constantly shifting the contact point

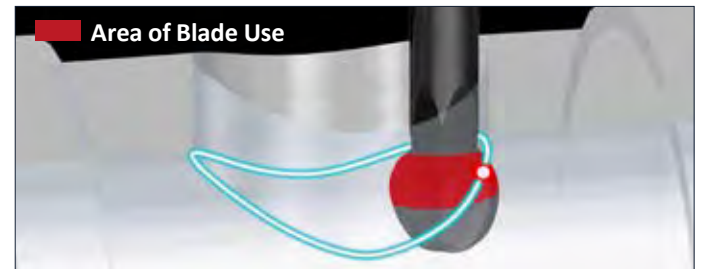

Tapped Holes



3 to 5 times Faster than Similar Tools

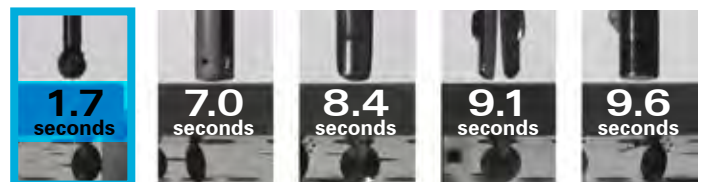

Uniform edge shape by consistent deburring amount

Watch the video: www.deburringtechnologies.com/learnmore



Try our online Application Tool

Determine if your Application is a fit.
The results are immediately available.



<https://xebec-backburr-cutter.com/>



Neck Down Shank

EDP	Part No.	D1 Shank Diameter		D2 Neck Diameter		D3 Cutter Diameter		L1 Overall Length		L3 Neck Length		Blades
		MM	INCHES	MM	INCHES	MM	INCHES	MM	INCHES	MM	INCHES	
51000	XC-08-A	3	0.118	0.48	0.019	0.8	0.031	60	2.362	4.2	0.165	2
51001	XC-13-A	3	0.118	0.78	0.031	1.3	0.051	60	2.362	6.7	0.264	2
51002	XC-18-A	3	0.118	1.1	0.043	1.8	0.071	60	2.362	8.2	0.323	2
51013	XC-23-A	3	0.118	1.4	0.056	2.3	0.091	70	2.756	12.5	0.492	2
51003	XC-28-A	4	0.157	1.7	0.067	2.8	0.110	70	2.756	12.2	0.480	2
51014	XC-33-A	4	0.157	2	0.079	3.3	0.130	70	2.756	17.5	0.689	2
51004	XC-38-A	4	0.157	2.4	0.094	3.8	0.150	70	2.756	16.2	0.638	2
51005	XC-48-A	6	0.236	3	0.118	4.8	0.189	70	2.756	20.2	0.795	2
51006	XC-58-A	6	0.236	3.5	0.138	5.8	0.228	70	2.756	24.2	0.953	2
51015	XC-78-A	8	0.315	4.7	0.185	7.8	0.307	100	3.937	40	1.575	3
51016	XC-98-A	10	0.394	5.9	0.232	9.8	0.354	120	4.724	50	1.969	3

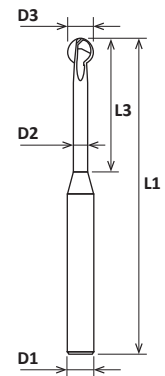

Straight Shank

EDP	Part No.	D1 Shank Diameter		D2 Shaft Diameter		D3 Cutter Diameter		L1 Overall Length		L3 Shaft Length		Blades
		MM	INCHES	MM	INCHES	MM	INCHES	MM	INCHES	MM	INCHES	
51007	XC-18-B	1.1	0.043	1.1	0.043	1.8	0.071	50	1.969	48.2	1.898	2
51017	XC-23-B	1.4	0.056	1.4	0.056	2.3	0.091	60	2.362	57.7	2.272	2
51008	XC-28-B	1.7	0.067	1.7	0.067	2.8	0.110	70	2.756	67.2	2.646	2
51018	XC-33-B	2	0.079	2	0.079	3.3	0.130	80	3.149	76.7	3.020	2
51009	XC-38-B	2.4	0.094	2.4	0.094	3.8	0.150	85	3.346	84.62	3.331	2
51010	XC-48-B	3	0.118	3	0.118	4.8	0.189	105	4.134	100.2	3.945	2
51011	XC-58-B	3.5	0.138	3.5	0.138	5.8	0.228	120	4.724	114.2	4.496	2

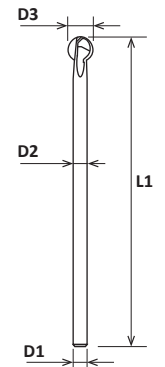

Detailed Finishing

A close-up, high-angle shot of a metal part, possibly a gear or a similar component, being finished. The surface is highly reflective and shows intricate patterns of light and shadow, indicating a fine, polished texture. A red-handled tool, likely a deburring or finishing tool, is visible in the lower right quadrant, applying pressure to the metal. The background is a warm, orange-red gradient, which complements the overall aesthetic of the image.

Xebec™ Micro Motor

Portable, battery-powered rotary tool

EDP	Item	Part No.
52000	Xebec Micro Motor	M2P33ST

Easy To Use

Small-size, lightweight, and mobile system for quick manual deburring/polishing solutions.

Best solution for users who use XEBEC hand solutions, but require the productivity of machine tools on the shopfloor.

Digital RPM display supports safe use of XEBEC tools.

Stronger torque allows Xebec tools to cut freely under load.

Handpiece

Speed: 0-30,000

Maximum Torque: 3.5 Ncm

Weight: 0.3 lbs

Control Unit

Battery: Rechargeable Li-Ion

Operating time: approx. 5 hrs

Charge time: 3 hrs

Dimensions: 2.6" x 5" x 1.2"

Weight: 0.6 lbs



Use with these XEBEC™ 3mm Shank Tools



XEBEC STONE™
Meister Rods





XEBEC BRUSH™

End Type Brush

Ideal for cutter-mark removal, polishing and finishing of parts with narrow features.

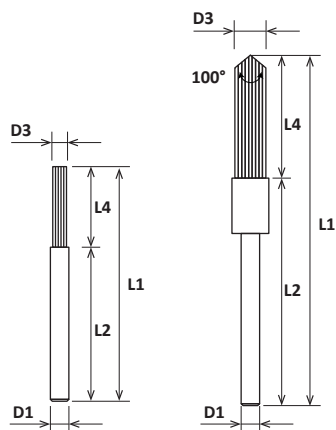

Brush Size (D3)		Aggressiveness				D1 Shank Diameter		L1 Overall Length		L2 Shank Length		L4 Brush Length		Max RPM
MM	INCHES	Pink	Red	White	Blue	MM	INCHES	MM	INCHES	MM	INCHES	MM	INCHES	
1mm	0.039	30050 A13-EB01S	30054 A11-EB01S	-	-	3	0.118	52	2.047	37	1.457	15	0.591	15,000
1.5mm	0.059	30051 A13-EB015S	30055 A11-EB015S	-	-									
2mm	0.079	30052 A13-EB02S	30056 A11-EB02S	-	-									
2.5mm	0.098	30053 A13-EB025S	30057 A11-EB025S	-	-									
3mm	0.118	30014 A13-EB03M	-	-	-	3	0.118	67	2.638	28	1.102	30	1.181	6,000
5mm	0.19	-	60001 A11-EB06M	60002 A21-EB06M	60006 A32-EB06M	3	0.118	58	2.28	28	1.10	20	0.79	15,000

*60001, 60002 has 100 degree angled tip

Brush Color	Pink	Red	White	Blue
Aggressiveness	Least ← → Most			
Target Material	Resin	General steel	Stainless steel	
	Copper/Brass		Heat-resistant steel	
	Aluminum	Hardest materials	Cast-iron	
Burr Thickness	Micro fine burrs	Burr root thickness up to 0.004"		
		Up to 0.008"		
Target Finish	4 Ra or better		Up to 4 Ra	

Stone Mounted Point

Ideal for use with pneumatic tools at high rotational speed.
Cutting edges exposed across the entire surface.

Stone Color	Gray
Grit	#220



Head	EDP	Part No.	D1		D2		D3		L1		L2		L3		L4		Max RPM
			Shank Diameter	Neck Diameter	Stone Diameter	Overall Length	Shank Length	Neck Length	Stone Length								
			MM	INCHES	MM	INCHES	MM	INCHES	MM	INCHES	MM	INCHES	MM	INCHES	MM	INCHES	
Cylinder Shaft	60003	AX-PM-5RF	3	0.118	1.5	0.059	5	0.197	48	1.890	30	1.181	10	0.394	8	0.315	30,000
Solid Cylinder	60004	AX-PM-3R	3	0.118	5	0.197	3	0.118	48	1.890	20	0.787	8	0.315	20	0.787	60,000
Pointed tip	60005	AX-PM-6T	3	0.118	8	0.315	6	0.236	48	1.890	20	0.787	8	0.315	20	0.787	60,000

*60005 has 100 degree angled tip

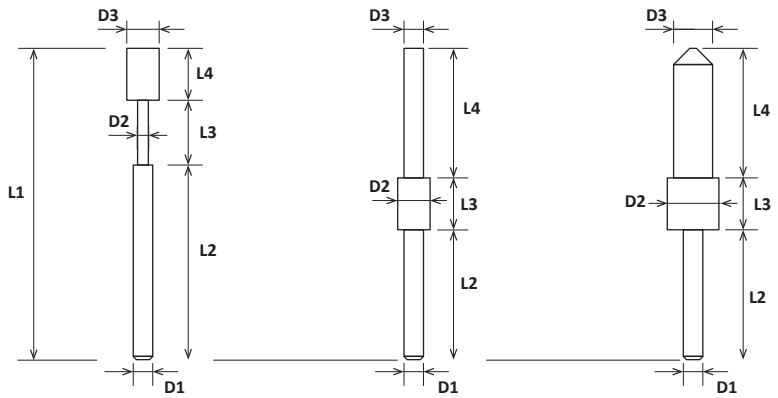

Meister Finish

Additional sizes available. Please allow 2-3 week delivery on all Meister Finish products.

Stick Type Tip cutting ceramic fiber stone

Dimension (mm)			Red #1200	White #1000	Blue #800	Black #600	Orange #400	Light Brown #300	Dark Brown #220	Violet #120
T	W	L								
0.5	4	100	70043	70049	70017	70061	70067	70073	70010	-
	6	100	70045	70052	70057	70063	70069	70080	70085	-
	10	100	70047	70054	70059	70065	70071	70082	70087	-
0.8	4	100	70091	70096	70077	70105	70620	70076	70014	-
	6	100	70092	70097	70078	70106	70621	70077	70015	-
1	1	100	70127	70135	70141	70148	70155	70337	70167	-
	2	100	70128	70012	70142	70621	70019	70161	70050	70173
	4	100	70001	70002	70003	70004	70005	70006	70007	70008
	6	100	70025	70026	70027	70028	70029	70030	70031	70032
	10	100	70133	70018	70078	70153	70016	70013	70075	70178
2	4	100	70235	70242	70249	70256	70263	70270	70277	70283
	6	100	70237	70244	70251	70258	70265	70272	70279	70285
3	4	100	70289	70295	70301	70307	70313	70319	70325	70331
	6	100	70291	70297	70303	70309	70315	70321	70327	70333

Heat Resistant

Stick will not soften, heat-resistant to 392 °F



Ultrasonic

Stick Type

Dimension (mm)			Red #1200	Blue #800	Dark Brown #220	Violet #120
T	W	L				
1	4	100	70683	70705	70706	70690
	6	100	70684	70686	70688	70691
	10	100	70685	70687	70689	70692
2	4	100	70693	70696	70699	70702
	6	100	70694	70697	70700	70703
	10	100	70695	70698	70701	70704

Diamond

Contains diamond abrasive fiber for materials harder than 57 HRC

For polishing and EDM scale removal



Ultrasonic

Stick Type

Dimension (mm)			Black #200	Blue-Green #400	Gray #800
T	W	L			
1	4	100	70900	70901	70902
	6	100	70903	70905	70907
	10	100	70904	70906	70908

Rod Type

Dimension (mm)		Blue-Green #400
D	L	
3	50	70909
	100	70910



Stick Holder For manual use

EDP	Part	STICK WIDTH	
		MM	INCH
70962	SSH-4	4	0.157
70963	SSH-6	6	0.236
70964	SSH-10	10	0.393



Rod Holder For manual use

EDP	Part	ROD DIAMETER	
		MM	INCH
70967	SNH-20	2-2.34	0.07-0.09
70968	SNH-30	3	0.118

Rod Type Ceramic fiber cutting edges are exposed over the entire surface



Dimensions (mm)		Red #1200	White #1000	Blue #800	Black #600	Orange #400	Light Brown #300	Gray #220
D	L							
1	50	70626	70628	70630	70632	70634	70636	70638
	100	70627	70629	70631	70633	70635	70637	70639
1.5	50	70614	70640	70642	70615	70644	70646	70648
	100	70625	70641	70643	70624	70645	70647	70649
2	50	70650	70652	70654	70656	70658	70660	70662
	100	70651	70653	70655	70657	70659	70661	70663
2.34	50	70616	70672	70617	70675	70677	70618	70619
	100	70671	70673	70674	70676	70678	70679	70680
3	50	70600	70601	70602	70603	70604	70605	70606
	100	70613	70612	70611	70610	70609	70607	70608
	150	70664	70665	70666	70667	70668	70669	70670

Use 3mm Diameter Rods in Xebec Micro Motor

Pencil



EDP	Part	Color, Grit	T		W		L		Pencil Holder	Qty. Per Pack
			MM	IN	MM	IN	MM	IN		
70950	A-R-0505S	Red #1200	0.5	.019	0.5	.019	50	1.969	70960	3 stones
70952	A-B-0505S	Blue #800								
70951	A-R-0909S	Red #1200	0.9	.036	0.9	.036	50	1.969	70961	
70953	A-B-0909S	Blue #800								

Pencil Holder

0.5 mm Holder
70960
PCL05



0.9 mm Holder
70961
PCL09



Flexible Shaft Stone

Soft contact abrasive ceramic fiber stone. Cutting edges exposed across the entire surface.
For deburring crossholes and detailed finishing of parts

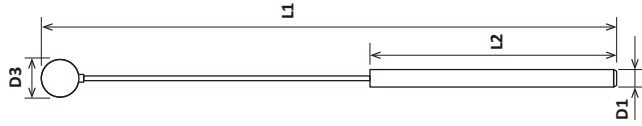

Ball Type

Ball Size (D3)		L1 Overall Length		D1 Shank Diameter		L2 Shank Length		Aggressiveness			Max RPM
MM	INCHES	MM	INCHES	MM	INCHES			Less ←	→ More		
3mm	0.118	71.5	2.815	3	0.118	30	1.181	Blue - #800	Orange - #400	Gray - #220	15,000
								10001 CH-PB-3B	10008 CH-PO-3B	10015 CH-PM-3B	
4mm	0.157	73	2.874					10002 CH-PB-4B	10009 CH-PO-4B	10016 CH-PM-4B	
5mm	0.197	72	2.835					10003 CH-PB-5B	10010 CH-PO-5B	10017 CH-PM-5B	
6mm	0.236	75	2.953					10004 CH-PB-6B	10011 CH-PO-6B	10018 CH-PM-6B	
10mm	0.393	72.5	2.854						10027 CH-PM-10B	7,000	
3mm	0.118	152.5	6.004	2.3	0.091	-	-			10080 CH-PM-3B-L	1,000
4mm	0.157	151.5	5.965							10081 CH-PM-4B-L	3,000
5mm	0.197	153	6.024							10082 CH-PM-5B-L	3,000
6mm	0.236	152	5.984							10083 CH-PM-6B-L	3,000

10mm Ball Available Upon Request

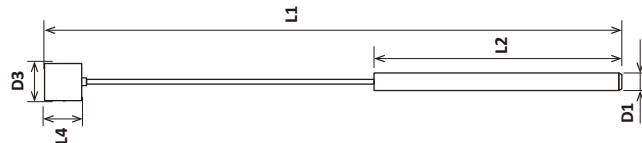

Cylinder Type

Cylinder Size (D3 x L4)		L1 Overall Length		D1 Shank Diameter		L2 Shank Length		Aggressiveness			Max RPM
MM	INCHES	MM	INCHES	MM	INCHES	MM	INCHES	Less ←	→ More		
3 x 3	0.118 x 0.118	71.5	2.815	3	0.118	30	1.181	Blue - #800	Orange - #400	Gray - #220	15,000
								10005 CH-PB-3R	10012 CH-PO-3R	10019 CH-PM-3R	
4 x 4	0.157 x 0.157	72	2.835					10006 CH-PB-4R	10013 CH-PO-4R	10020 CH-PM-4R	
5 x 5	0.197 x 0.197	72.5	2.854					10007 CH-PB-5R	10014 CH-PO-5R	10021 CH-PM-5R	
5 x 10	0.197 x 0.393	75	2.953							10022 CH-PM-5R-C01	12,000

See Operating Parameters for Surface Brush page 19

Operating Parameters

For help with applications and operating parameters, call the Xebec Deburring Technologies Technical Hotline:

1-800-434-9775

More operating parameters and tech tips online at deburringtechnologies.com

XEBEC BRUSH™ SURFACE

For Crosshole Deburring of Large Diameters

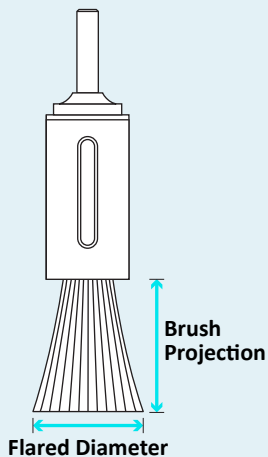

Brush Size	EDP	RPM	Brush Projection					
			1.181"	1.574"	1.771"	1.968"	2.362"	2.755"
			Flared Diameter					
15 mm	30005 A11-CB15M	6000 rpm	1.023"	1.771"	2.165"	2.362"	-	-
		5000 rpm	0.984"	1.417"	1.574"	1.968"	-	-
		4000 rpm	0.826"	1.062"	1.062"	1.062"	-	-
	30011 A21-CB15M	6000 rpm	0.984"	1.417"	1.811"	2.283"	-	-
		5000 rpm	0.866"	1.062"	1.062"	1.417"	-	-
		4000 rpm	0.826"	0.866"	0.866"	0.905"	-	-
25 mm	30004 A11-CB25M	5000 rpm	1.574"	2.519"	3.346"	4.173"	-	-
		4000 rpm	1.456"	1.771"	2.874"	3.385"	4.724"	-
		3000 rpm	1.377"	1.692"	2.204"	2.992"	4.094"	4.724"
	30010 A21-CB25M	5000 rpm	1.377"	1.771"	2.755"	2.755"	4.015"	-
		4000 rpm	1.299"	1.653"	2.244"	2.244"	2.992"	3.661"
		3000 rpm	1.259"	1.456"	1.811"	1.811"	2.362"	2.559"
40 mm	30003 A11-CB40M	4000 rpm	-	-	3.700"	4.330"	-	-
		3000 rpm	1.968"	2.401"	2.874"	3.346"	4.842"	-
		2000 rpm	1.811"	2.165"	2.283"	2.559"	3.425"	4.330"
		1000 rpm	1.771"	1.850"	1.929"	1.968"	2.047"	2.086"
	30009 A21-CB40M	4000 rpm	-	-	2.755"	3.267"	-	-
		3000 rpm	1.850"	2.125"	2.440"	2.716"	3.543"	4.527"
		2000 rpm	1.771"	1.929"	2.165"	2.244"	2.559"	2.834"
		1000 rpm	1.692"	1.732"	1.732"	1.732"	1.771"	1.811"

XEBEC BRUSH™ SURFACE Operating Conditions

Target Burr Size

Burr Root Thickness of **0.008"** or less
(Burrs are bent with a fingernail)

Burr Root Thickness

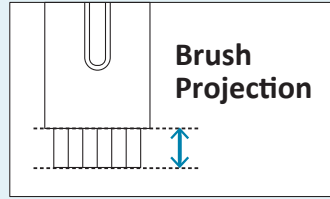
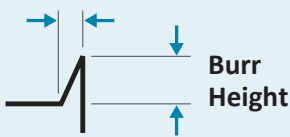

Brush Size Diameter	6 mm	15 mm	25 mm	40 mm	60 mm	100 mm
Brush Projection All Grades (in)	0.3125-0.375"	0.375-0.5625"	0.5-0.625"	0.5-0.625"	0.5-0.75"	0.5-0.75"

Brush projection below 0.2" increases grinding power and may affect finish

Workpiece Engagement

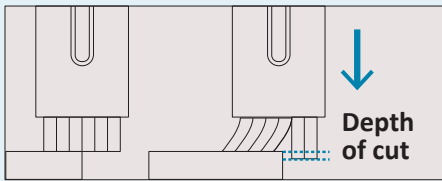

Engage part with the tip of the brush. Avoid contacting the side of the brush.

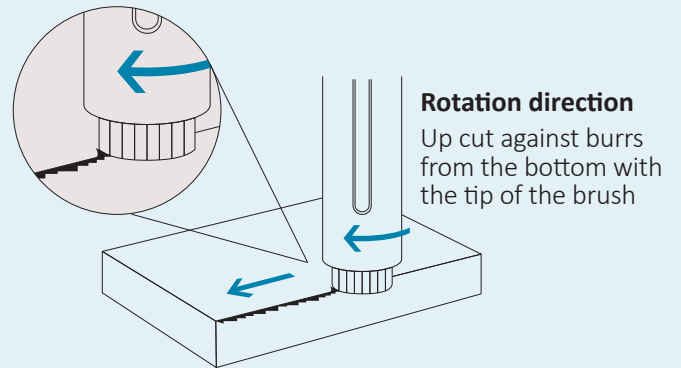
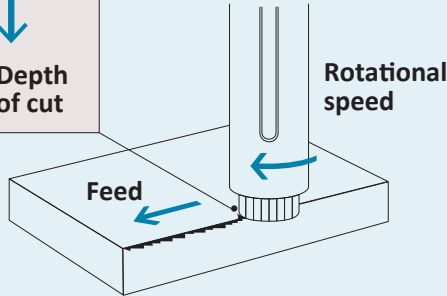

Rotation direction
Up cut against burrs from the bottom with the tip of the brush

Depth of Cut All Brush Grades (Inches)

Polishing	Vertical Burr	Horizontal Burr	Heavy Burr
0.012"	0.020"	0.040"	0.060"

Maximizing Performance

Maximizing Deburring Operation

- 1 Increase RPM to the maximum allowed
- 2 Decrease feed rate in 10% increments
- 3 Do not change original parameters, but increase number of passes
- 4 Try a more aggressive brush that will increase grinding power

Maximizing Tool Life

- 1 Decrease RPM in 10% increments
- 2 Increase feed rate by 10% increments
- 3 Try another brush color A13 Pink, A21 White, A11 Red, A32 Blue with the same parameters

Use of Coolant/Oil will optimize results

- > It will Extend Tool Life
- > Improves Surface Finish

Starting Operating Parameters for Automated Machining

Material	SFPM	Brush Size (Diameter)		6 mm	15 mm	25 mm	40 mm	60 mm	100 mm	Feed Rate	
		Initial Brush Projection		0.3125-0.375"	0.375-0.5625"	0.5-0.625"	0.5-0.625"	0.5-0.75"	0.5-0.75"	Finishing	Deburring
		Maximum RPM		10,000	6,000	5,000	3,000	2,000	1,000	IPM	IPM
		1st Choice	2nd Choice	RPM	RPM	RPM	RPM	RPM	RPM		
Low Carbon Steel	600	○ White	● Blue	9,707	3,883	2,330	1,456	971	582	47	94
Medium Carbon Steel	550	○ White	● Blue	8,898	3,559	2,136	1,335	890	534	40	80
High Carbon Steel	500	○ White	● Blue	8,089	3,236	1,941	1,213	809	485	34	67
Cast Steel	450	● Blue	○ White	7,280	2,912	1,747	1,092	728	437	27	54
300 Series Stainless	525	○ White	● Red	8,494	3,397	2,038	1,274	849	510	47	94
400 Series Stainless	575	○ White	● Red	9,303	3,721	2,233	1,395	930	558	47	94
Grey Cast Iron	400	● Blue	○ White	6,471	2,589	1,553	971	647	388	54	107
Ductile Cast Iron	350	● Blue	○ White	5,662	2,265	1,359	849	566	340	47	94
Alloy Cast Iron	300	● Blue	○ White	4,854	1,941	1,165	728	485	291	40	80
Aluminum Cast Alloys	700	● Red	○ White	10,000	4,530	2,718	1,699	1,132	679	80	161
Aluminum Diecast Alloys	800	● Red	○ White	10,000	5,177	3,106	1,941	1,294	777	74	147
Aluminum Wrought Alloys	900	● Red	○ White	10,000	5,824	3,495	2,184	1,456	874	67	134
Zinc Diecastings	800	● Red	○ White	10,000	5,177	3,106	1,941	1,294	777	67	134
Copper	600	● Red	○ White	9,707	3,883	2,330	1,456	971	582	60	121
Brass, Free Machining	600	● Red	○ White	9,707	3,883	2,330	1,456	971	582	74	148
Cast Bronze	500	● Red	○ White	8,089	3,236	1,941	1,213	809	485	47	94
Nickel Alloys	200	● Blue	○ White	3,236	1,294	777	485	324	194	40	80
Titanium Alloys	200	● Blue	○ White	3,236	1,294	777	485	324	194	40	80
Plastic, Thermosetting	500	○ Pink	● Red	8,089	3,236	1,941	1,213	809	485	80	161
Plastic, Thermoplastic	800	○ Pink	● Red	10,000	5,177	3,106	1,941	1,294	777	80	161

Adjustments for Improved Results

If burrs or cutter marks remain

- 1 Increase Rotational Speed**
In increments of 25%, Do not exceed Maximum RPM
- 2 Increase the Number of Passes**
Each pass will improve finish by approximately one half
- 3 Decrease Feed Rate**
In increments of 10 to 20%
- 4 Use more aggressive Color of Brush**
(Pink=Least Aggressive, Blue=Most Aggressive)

Increase Grinding Power

Feed Rate	Rotational Speed	Depth of Cut
▼	▲	▲

Decrease Grinding Power

Feed Rate	Rotational Speed	Depth of Cut
▲	▼	▼



DEBURRING
TECHNOLOGIES

Now Available XEBEC™ Kits

Big savings on a selection of popular products. Kits come packed and labeled in a durable hardshell case with protective foam insert.

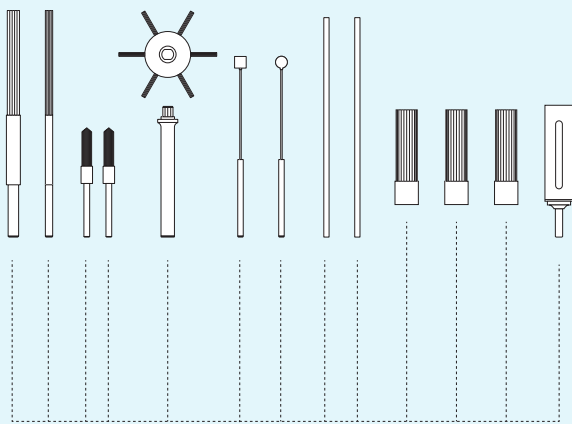

14-pc Basic Kit

#82001

Included EDP's will vary by availability

Kit includes:

- Wheel Brush (1)
- Wheel Brush Shaft (1)
- 15mm Brush Sleeve (1)
- 15mm Surface Brush (3)
- Stone Flexible Shaft (2)
- Meister Finish Stick (2)
- End-Type Brush (2)
- Crosshole Brush (2)

19-pc Premium Kit

#82000

Included EDP's will vary by availability

Kit includes all items from Basic Kit shown above PLUS:

- Floating Holder (1)
- Floating Holder Bushing (2)



Case Dimensions: LENGTH: 12 in x WIDTH: 8 in x HEIGHT: 3 in

TEST TOOL POLICY Due to the unique design of Xebec products, we have achieved optimal success when Deburring Technologies technical personnel assist in the selection of proper tool and operating parameters. Provided our representative has reviewed an application and provided processing recommendations, we are pleased to provide reasonable quantities of test product with a "Guaranteed Trial" purchase order. Such product will be invoiced and is payable per our normal NET – 30 DAY terms. Should the product not perform as promised, simply contact us for a return authorization within forty five (45) days of purchase with a written report of how the product failed to meet the promised performance. Once we have received and inspected the product, we will issue full credit for the returned product. All returns for other than guaranteed trial performance must be received within thirty (30) days from date of purchase and be received in new condition in the original packaging. Once we have received and inspected the product, we will issue full credit for the returned product.

SAFETY WARNING Cutting fiber brushes and stones are cutting tools and are often rotated at high speeds with a power tool or in a machine tool. They should never be operated at higher than the maximum speeds listed. When using these tools, safety glasses and gloves should be worn. Breathing the dust created by using these products for prolonged periods of time should be avoided.